

REVISION RECORD				
REV	ECN	DESCRIPTION	DRFT	DATE

H

G

F

E

D

C

B

A

H

G

F

E

D

C

B

A

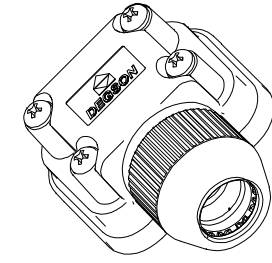
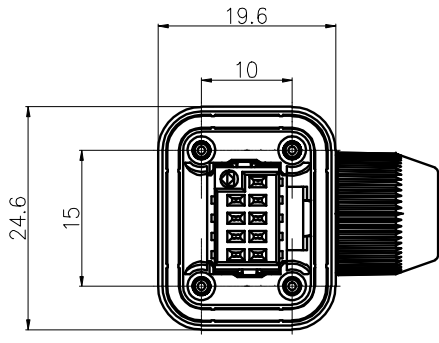
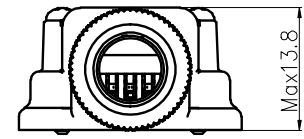
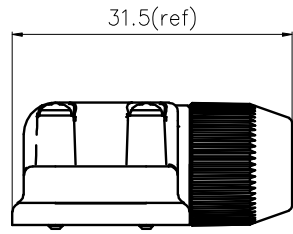

NOTES:

- 1. Rated voltage/current : 10Vac /1A
- 2. Insulation resistance: >100MΩ
- 3. Insulation plastic: Engineering plastic
- 4. Operating temperature: -20°C~+105°C
- 5. Cable range Ø6.4mm ~ Ø7.0mm
- 6. RoHS Compliance
- 7. Tolerance: .x ±0.25
.xx ±0.1
∠ ± 1'

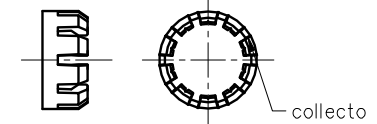
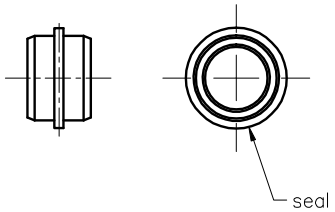
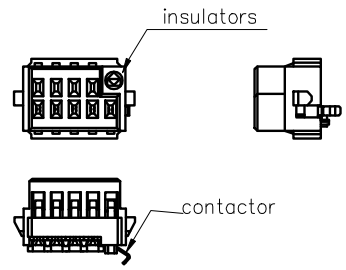
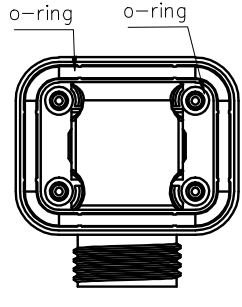
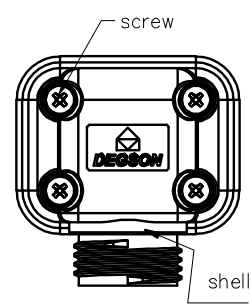
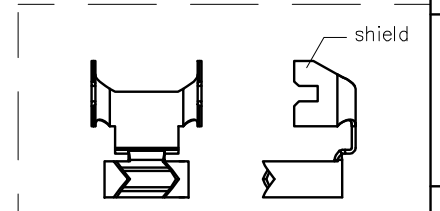

DETACHED LISTS	PART NO.: 24030000008		DEGSON 宁波高松电子有限公司 NINGBO DEGSON ELECTRICAL CO., LTD	
	APPD:		NAME:	
	CHKD:		DGFA9S-B1-00A(H)	
	DRFT: GQ 2019.03.29		TITLE: CUSTOMER DRAWING	REV: DO-1
THIRD ANGLE PROJECTION		DRAWING NO.: DGFA9S-B1-E01	SHEET: 1/1	
		MM (INCH)	DO NOT SCALE DRAWING	SCALE: 1:1