

PCB LAYOUT

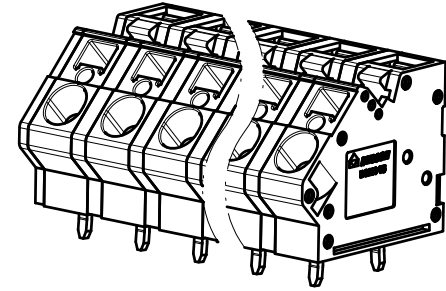
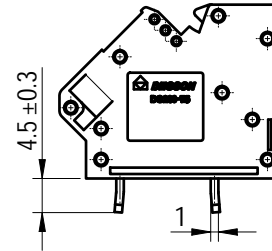
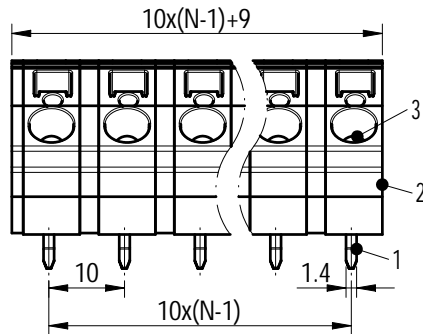
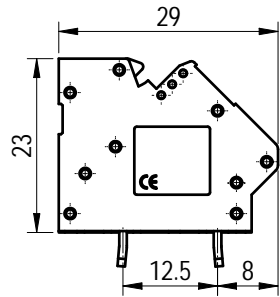
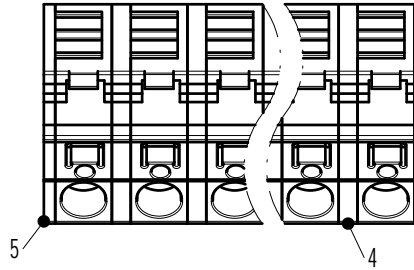
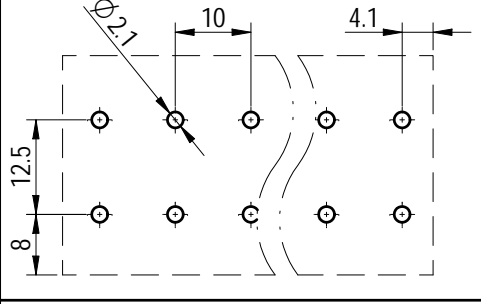

Note: The A&Z (H) in the name means: A(H) and Z(H).

ITEM	NAME OF PART	MATERIAL	NOTES
5	Cover	PA66	UL94V-0
4	Clapboard	PA66	UL94V-0
3	Spring	Stainless steel	/
2	Housing	PA66	UL94V-0
1	Pin header	Copper	Sn plated

UL 标准/UL Standard:		B	C	D
额定电压/电流/Rated Voltage(V)/Current(A)		300/30	/	/
IEC 标准/IEC Standard:				
过压类别/Overvoltage Category/污染等级/Pollution Degree		III/3	III/2	II/2
额定电压/电流/Rated Voltage(V)/Current(A)		630/32	630/32	1000/32
额定脉冲电压(KV)/Rate Impulse Voltage(KV)		6	6	6
线径范围(硬线和软线)/Wire Range(rigid and flexible)(AWG/mm²)		24~10 / 0.2~4		
间距/Pitch(mm)/线数范围/Poles		10/N=02~08P		
剥线长度/Stripping length(mm)		10~11		
使用温度范围/Operating temperature(°C)		-40~+105		
符合RoHS环保要求/Conform to RoHS		Yes		

DEGSON

APPD: 兰春华 2022.12.28
 CHKD: 陈招 2022.12.28
 DRFT: 袁路易 2022.12.28

MATERIAL: -		SURFACE/COLOR:		
MAT NO./REV: - / 00.01		MAT STATUS: 批量		
NAME DG260-10.0-XXP-1Y-00A&Z(H)				
DRAWING NO. 200022352	TYPE CUSTOMER DRAWING	DRAWING STATUS 已发布	SCALE 1:1	SHEET 1/1

REV	ECN	DESCRIPTION	DRFT	DATE
00			袁路易	2022.12.28

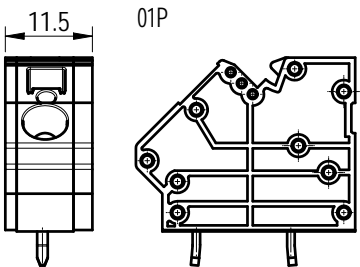

Transfer or duplication of this document as well as the utilization or communication of its content are prohibited unless authorized in writing by the copyright holder. All rights reserved for patent. 除专利声明外，其他内容均受法律保护。未经许可，不得复制或传播。本公司保留对涉及发明、实用新型及外观设计的所有权利。